

OPERATIONAL LOADS OF POWER SYSTEMS OF BUCKET DREDGERS IN MAIN SERVICE STATES

Damian Bocheński

*Gdańsk University of Technology
Ul. Narutowicza 11/12, 80-952 Gdańsk, Poland
Tel. +48 58 3472773, fax: +48 58 3472430
e-mail: daboch@pg.gda.pl*

Abstract

This paper presents results of investigations of six bucket dredgers in service. The operational investigations consisted in measuring the parameters which characterize working conditions of power systems of the dredgers: operational loads of main engines as well as loads of electric generators which cover power demand from the side of auxiliary consumers.

Keywords: *bucket dredgers, power plants, ship power systems*

1. Introduction

Service states of bucket dredger significantly differ from those of a typical cargo ship. The main service state is that defined as “dredging operations”. The state is consisted of the following periods: digging connected with loosening and hoisting the loosened soil onto the dredger, possible transporting the winning to land by using dredging pump, as well as dredger manoeuvring over excavation site. From the point of view of power problems of the dredger the main state is that in which at least one main technological consumer operates, hence also the main engine (to drive main technological consumers). During breaks in dredging only the auxiliary engine operates.

The second service state, analogous to that on cargo ships, is “free -floating”. In the service state, manoeuvring or weathering periods can happen, depending on navigational situation. The state is characterized by a greater power demand than that for „dredging operations”, hence the power system of self- propelled bucket dredgers consists of two main engines; one of them operates during dredging and both during free-floating. The free-floating state takes place only on self-propelled dredgers. Most bucket dredgers are not fitted with self-propulsion system [5]. For them the „ towing” state is equivalent to that of ”free-floating”, however from the point of view of energy consumption the state is identical with breaks in dredging work.

The bucket dredger power system consisted of main engine(-s) and auxiliary engines, has the task to cover power demand from the side of main consumers (bucket chain, side winches , possible main drive propellers and dredging pump) and a group of auxiliary consumers. Generally the main engines operate to cover demand of main consumers, however in the basic service states they ensure energy also for driving auxiliary consumers (all or only a selected number of them).

The character of power system operational loads is best illustrated by the loads of main engines and electric generators for ship general purposes (covering power demand from the side of the group of auxiliary consumers).

In this paper are presented characteristics of real loads of main engines in both above mentioned service states of bucket dredgers as well as loads of electric generators intended for ship

general purposes. The generators - depending on a design solution of a given dredger – are driven either by auxiliary engines or both auxiliary and main engines.

2. Characteristics of power systems of the investigated bucket dredgers

The operational investigations were performed on five dredgers operating in the south Baltic Sea in the years 2000-2003 and 2005-2006 [3, 4] (during 732 measurement hours in total). The obtained results were supplemented by the data taken from the publication [7], they concern the sixth dredger, *Ivan Bachalov*. The main technical particulars of the dredgers on which the investigations in question were carried out, are presented in Tab. 1. The dredgers *Ivan Bachalov* and *Kategats* are of the same design.

The bucket dredger power systems appear in three basic types. The basic one is that in which main engine (-s) drives, during dredging, all main consumers as well as auxiliary ones, whereas auxiliary engine (-s) ensures drive for auxiliary consumers only during breaks in dredging operations [5]. Such system is installed on five investigated dredgers (Fig.1 and 2). Only the power system of the dredger *Małż II* (Fig.3) belongs to another type which is characterized by that its main engine (-s) drives main consumers and a selected, small number of auxiliary ones, whereas auxiliary engine (-s) ensures drive for the remaining, greater number of auxiliary consumers, in all service states [5]. The dredgers *Rozgwiazda*, *Inż. T. Wenda* and *Małż II* are not self-propelled, the dredger *Małż II* is additionally fitted with a silting-up system, hence the second main engine for driving the dredging pump is installed. The dredgers *Usedom*, *Ivan Bachalov* and *Kategats* are fitted with self-propulsion system, their power plants are consisted of two main engines.

Tab.1. Main particulars of bucket dredgers on which operational investigations were performed

Dredger	Main dimensions			$\sum N_{DE}^{nom}$	N_{ME}^{nom}	$\sum N_{AC}^{nom}$	Crew
	L _c	B	T				
	m	m	m	kW	kW	kW	persons
Małż II	33,1	8,8	1,80	630	205 ¹⁾ 272 ²⁾	136,5	8
Rozgwiazda	46,0	12,1	2,90	728	660 ¹⁾	310,4	10
Inż.T. Wenda	45,9	12,1	2,90	776	660 ¹⁾	315,5	10
Usedom	80,4	14,8	3,85	1926	970 ¹⁾ 970+735 ³⁾	1510	32
Kategats	79,9	14,4	3,75	1925	970 970+735 ³⁾	1560	32

$\sum N_{DE}^{nom}$ - total rated output power of diesel engines,

N_{ME}^{nom} - rated output power of main engines,

$\sum N_{AC}^{nom}$ - total rated output power of auxiliary consumers;

¹⁾ – output power of main engine driving main technological consumers and possible auxiliary consumers,

²⁾ – output power of main engine driving dredge pump,

³⁾ – output power of main engines under operation during free-floating.

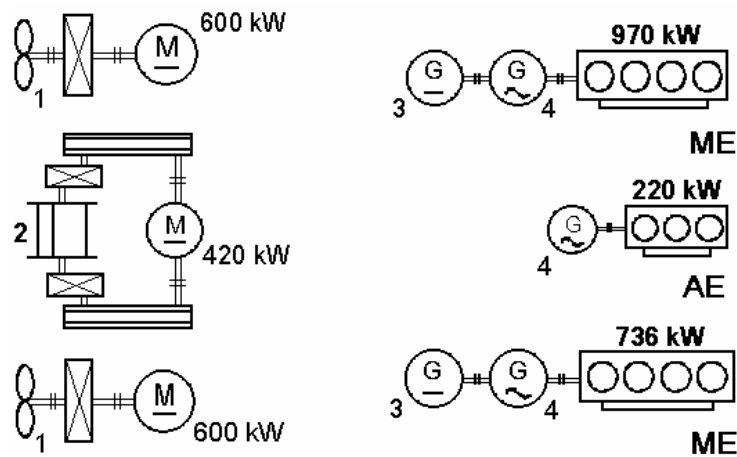

Fig. 1. Schematic diagram of the power system of the dredger „Kategats”: 1 – main screw propeller; 2 – upper tumbler driving bucket chain; 3 – main electric generator; 4 – electric generator for ship general purposes; ME – main engine; AE – auxiliary engine

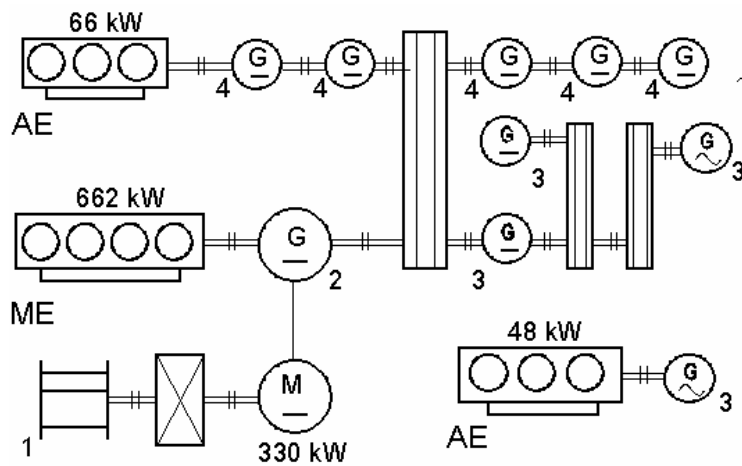

Fig. 2. Schematic diagram of the power system of the dredger „Inž. T. Wenda”: 1 – upper tumbler driving bucket chain; 2 – main electric generator; 3- electric generator for ship general purposes; 4 – electric generator of side winch; ME – main engine; AE – auxiliary engine

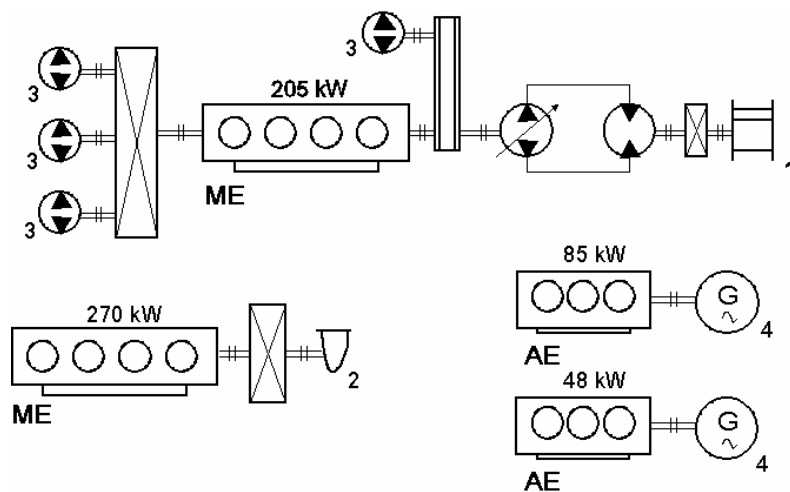

Fig. 3. Schematic diagram of the power system of the dredger „Maž II”: 1 – upper tumbler driving bucket chain; 3 – main electric generator; 2 – dredge pump; 3 – hydraulic pump for driving side and auxiliary winches; 4 – electric generator for ship general purposes; ME – main engine; AE – auxiliary engine

3. Operational loads of main engines

Long-lasting investigations of operational loads of main and auxiliary engines are of a statistical character. Data used in such investigations are instantaneous values of engine loads recorded in assumed time intervals.

Measuring process of loads of main engines was carried out indirectly by measuring loads of electric generators driven by a given main engine. The measurements were performed by means of specially designed measuring systems. Their description and characteristics are presented a.o. in [1, 2]. For the reason of high variability of loads of the main power consumer, i.e. bucket chain, the measurements of engine loads were taken every second. The loads of electric generators were determined by measuring voltage and current values at generator terminals (in most cases it was direct current machines). Next the loading of the main engine driving a given electric generator was calculated on the basis of the known generator efficiency characteristics. In the case where several electric generators were driven by one main engine the loads were summed up.

The values of main engine loads obtained this way were taken for determining the following parameters of load characteristics distributions:

N_{ME}^{av} - average load of main engine, kW;

$\bar{N}_{ME}^{av} = \frac{N_{ME}^{av}}{N_{ME}^{nom}}$ - average relative load of main engine, -;

σ_{ME} - standard deviation of main engine load distribution, kW;

$\nu_{ME} = \frac{\sigma_{ME}}{N_{ME}^{av}}$ - coefficient of variance of main engine load distribution, -.

The characteristics of main engine load distributions for the investigated dredgers are given in Tab.2. The main engine load distributions are presented in Fig. 4 and 5.

Tab.2. The characteristics of main engine load distributions of six bucket dredgers in dredging and free-floating states

Name of dredger	Dredging state Medium and light soils				Free-floating state			
	N_{ME}^{av}	\bar{N}_{ME}^{av}	σ_{ME}	ν_{ME}	N_{ME}^{av}	\bar{N}_{ME}^{av}	σ_{ME}	ν_{ME}
	kW	-	kW	-	kW	-	kW	-
Inż. T. Wenda	170,4	0,258	45,1	0,265	-	-	-	-
Rozgwiazda	154,1	0,233	48,8	0,314	-	-	-	-
Małż II	50,2	0,245	17,9	0,357	-	-	-	-
Usedom	383,9	0,396	71,6	0,187	-	-	-	-
Kategats	401,5	0,414	86,9	0,216	793,1	0,465	309,3	0,390
Ivan Bachalov	421,3	0,434	107,7	0,256	920,7	0,540	283,8	0,307
average		0,331		0,266		0,503		0,349

The performed calculations of the parameters of main engine load distributions during dredging showed that the average relative loads of particular dredgers were contained in the range from 0,233 to 0,434 with the average value of 0,331, and the coefficient of distribution variance - in the range from 0,187 to 0,357 with the average value of 0,266. It should be mentioned that the maximum loads of main engines were contained in the range from 0,532 to 0,714. It may speak for some power margin during operations carried out in hard soils or – more probably – for highly over-dimensioned main engines.

For the free-floating state, values of the average main engine load are significantly higher than those during dredging when also greater numbers of engines operate. The relative loads were contained within the range of 0,465–0,54 with the average value of 0,503. Higher are also coefficients of variance – their average value amounts to 0,349. The so great value of coefficient of variance results from the character of free-floating state of bucket dredgers, which is characterized by short passages from port to dredging site and back, and a large number of manoeuvres.

Additionally, were performed investigations to check if it is possible to consider the relative load distribution of main engines normal one.

To confirm possible approximation of the empirical distributions of relative loads of main engines by means of normal distribution, were carried out the investigations in which the total distribution was analyzed of relative loads of engines of all investigated dredgers, normalized within the interval [0–1]. The engines' loads for the free-floating state were grouped in the left-sided, open quantifying intervals of width resulting from the splitting of rated power of main engines into 10 intervals. In the case of carrying dredging work the loads were grouped into 8 quantifying intervals as then the main engines operated under much smaller loads as compared with their rated output power values. The software *Statistica* was used for assessing the normality of variable distributions and preparing the normal distribution diagrams. The values of the variable in question have been drawn on the diagram of their dispersion respective to the expected values, under assumption that the distribution is normal. If the observed values comply with normal distribution then they have to run approximately along a straight line.

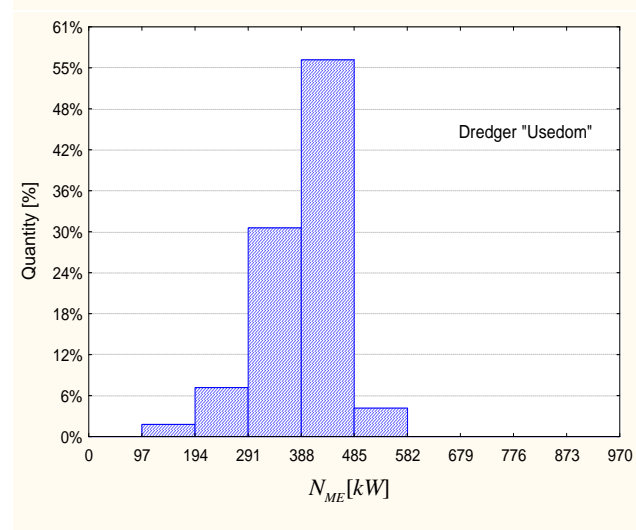
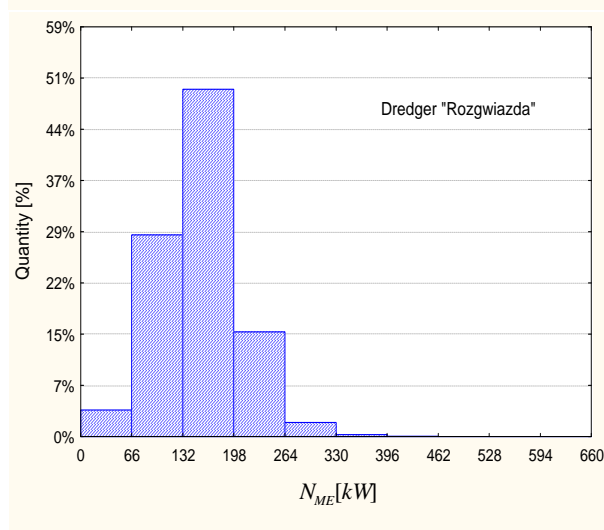
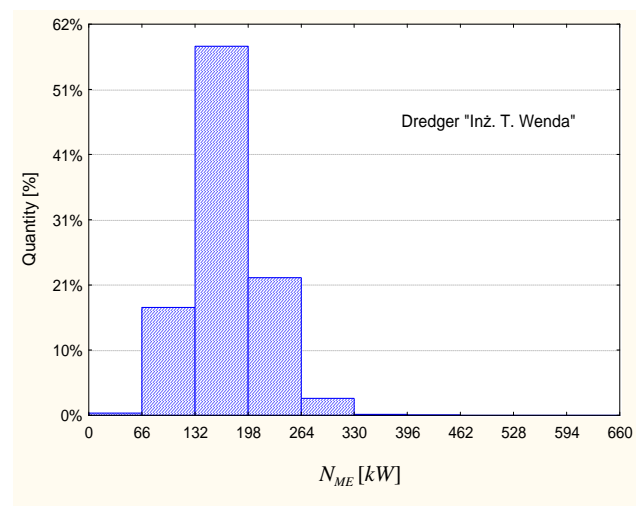
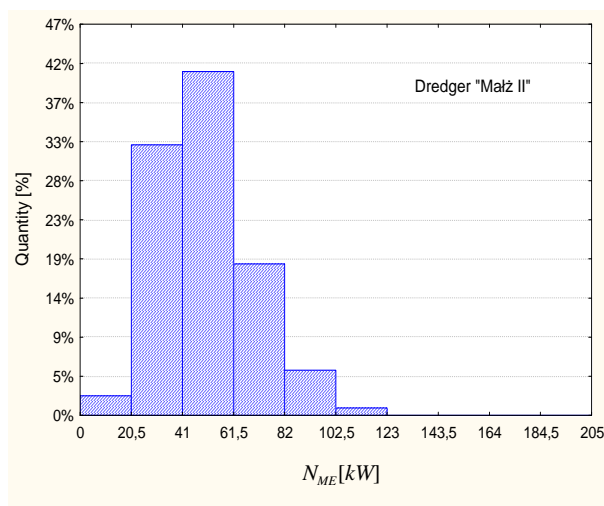

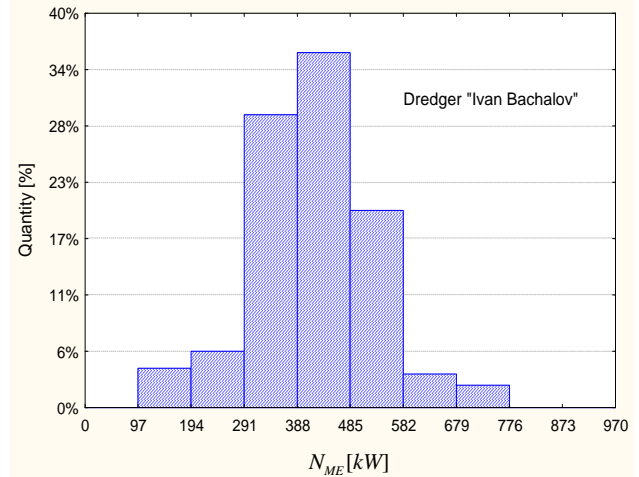
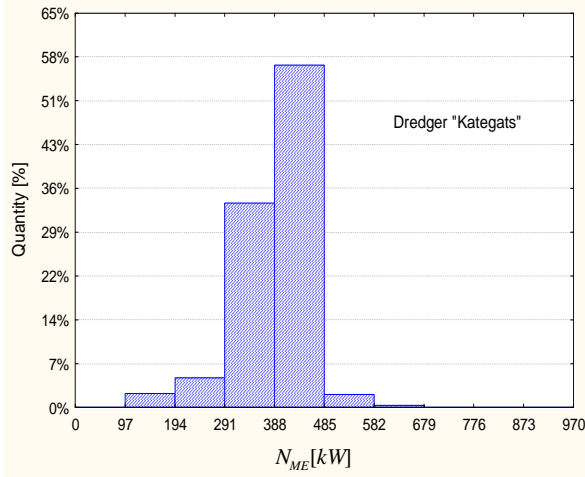

Rys. 4. Load distributions of main engines of bucket dredgers in dredging state

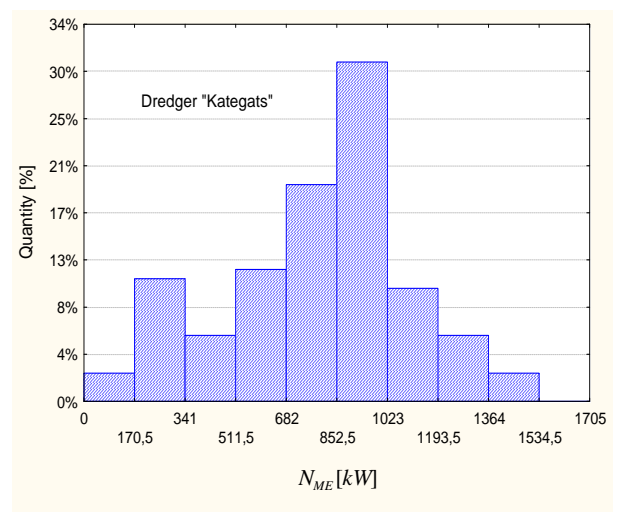
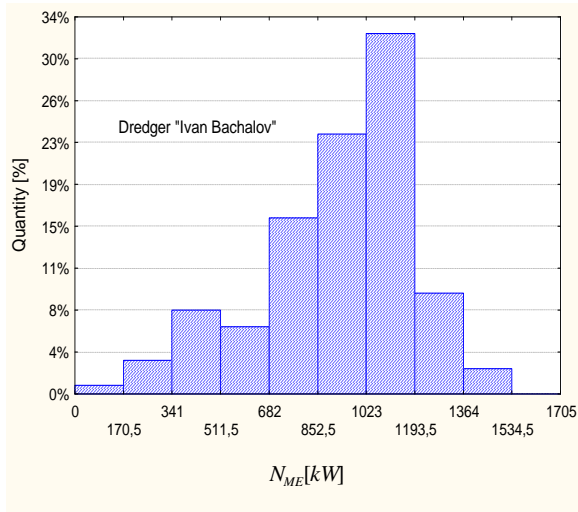

Rys. 5. Load distributions of main engines of bucket dredgers in free-floating state

The minimum sample size, m , under assumption of normal or nearly normal load distribution, was determined from the relation [6]:

$$m \geq \left(\frac{t_{\alpha} \times \bar{\sigma}}{d} \right)^2 \quad (1)$$

where:

t_{α} - critical value of the test for the confidence coefficient $(1 - \alpha)$ and $(m_0 - 1)$ degrees of freedom,

$\bar{\sigma}$ - relative value of standard deviation calculated from the sample of m_0 size,

d - assumed estimation error of average value.

By taking $\bar{\sigma}=0,07-0,12$ and $t_{\alpha}=1,96$ at $\alpha=0,05$ and $m_0 > 1000$ - on the basis of preliminary investigations - and assuming $d=0,01$, the minimum sample size $m=188-554$ was obtained. For all the investigated dredgers the sample sizes significantly exceeded the determined minimum one (95000 - 155000).

In Fig. 6a and 7a are presented the total load distributions of main engines of the investigated dredgers as well as the normal distribution probability density curves for both service states,

whereas in Fig. 6b and 7b - the normality diagrams of the tested distributions. Their runs, especially that regarding dredging work, indicate that the distribution can be considered normal.

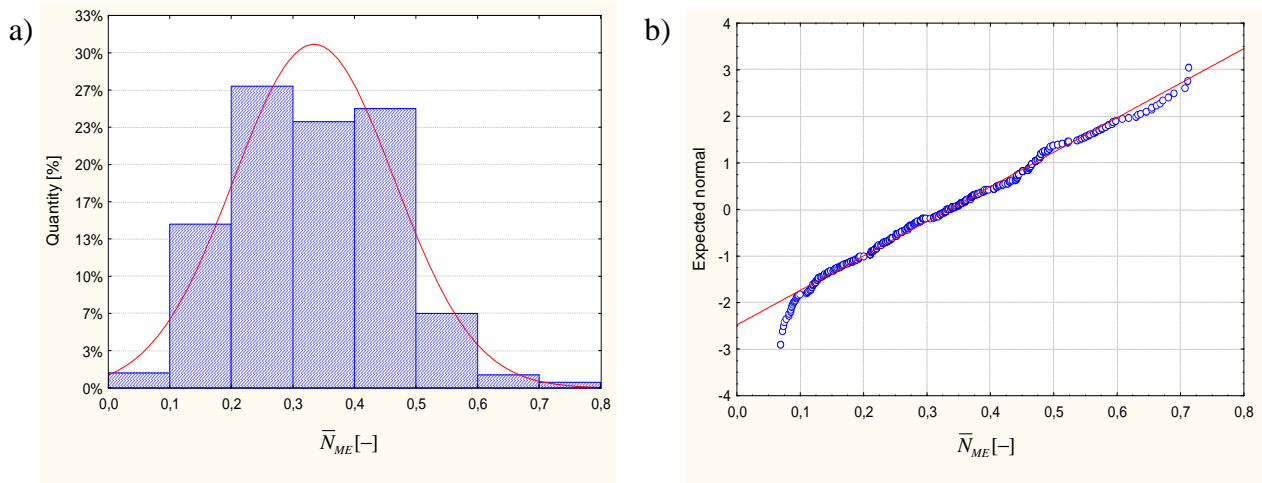

Fig. 6. Characteristics of the total load distribution of main engines of bucket dredgers in dredging state

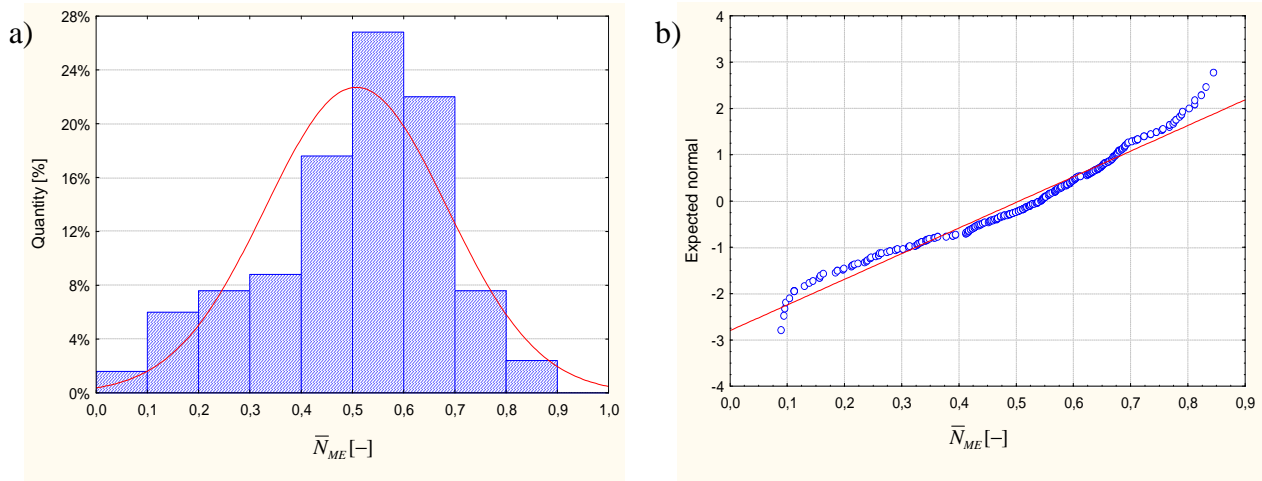

Fig. 7. Characteristics of the total load distribution of main engines of bucket dredgers in free-floating state

4. Operational loads of electric generators for ship general purposes

Load characteristics investigations of electric generators for ship general purposes were performed for two basic service states of bucket dredgers : dredging and free-floating, as well as – additionally – for the state of breaks in dredging (e.g. fuel bunkering, transporting the anchors , waiting for a dump barge) and towing.

On the dredger *Małż II* the ship general purposes electric generators were driven by auxiliary engines. On the dredgers *Rozgwiazda*, *Inż. T. Wenda*, *Kategats*, *Usedom* and *Ivan Bachalov* such electric generators were driven by main and auxiliary engines. The auxiliary engines operate only during breaks in dredging, during stays in ports, and towing.

Tab. 3, 4 and 5 contain calculated values of the parameters $(N_{EG}^{av}, \sigma_{EG}, \nu_{EG})$ of load distributions of electric generators for ship general purposes, values of the index $N_{EG}^{av} / \sum N_{AC}^{nom}$ for three service states of the dredgers, as well as the load ranges determined by values of the coefficient of the relative load range of electric generators for ship general purposes β_{EG} :

$$(\beta_{EG})_1 = \frac{N_{EG}^{av} - N_{EG}^{\min}}{\sigma_{EG}} ; \quad (\beta_{EG})_2 = \frac{N_{EG}^{\max} - N_{EG}^{av}}{\sigma_{EG}} \quad (2)$$

The example load distributions of electric generators for ship general purposes during dredging work of four investigated dredgers are shown in Fig. 8. As in the case of main engines, the loads were grouped into 10 quantifying intervals covering the range $N_{EG}^{\min} - N_{EG}^{\max}$.

The determined average values of variance coefficients for the ship general purposes electric generators amount to: $\nu_{EG}^{av}=0,241$ - for dredging state, $\nu_{EG}^{av}=0,192$ - for free-floating state, as well as $\nu_{EG}^{av}=0,175$ for breaks in dredging, for port staying and towing. And, the average values of relative variability range coefficients amount to $(\beta_{EG})_1=2,085$ and $(\beta_{EG})_2=3,508$ - for dredging state, $(\beta_{EG})_1=2,173$ and $(\beta_{EG})_2=2,896$ - for free-floating state, $(\beta_{EG})_1=1,949$ and $(\beta_{EG})_2=2,098$ - for the state of breaks in dredging, for port staying and towing.

Tab.3. Parameters of operational load distributions of ship general purposes electric generators of bucket dredgers in dredging state

Dredger	Parameters of load distribution of electric generator			Minimum load		Maximum load		$\frac{N_{EG}^{av}}{\sum N_{AC}^{nom}}$
	N_{EG}^{av}	σ_{EG}	ν_{EG}	N_{EG}^{\min}	$(\beta_{EG})_1$	N_{EG}^{\max}	$(\beta_{EG})_2$	
	kW	kW	-	kW	-	kW	-	
Małż II	19,38	3,51	0,181	10,8	2,442	25,6	1,772	0,142
Inż. T. Wenda	38,61	12,40	0,321	18,7	1,605	96,7	4,687	0,124
Rozgwiadza	34,95	12,11	0,346	17,1	1,475	88,2	4,401	0,113
Usedom	164,97	28,19	0,171	92,0	2,589	261,0	3,407	0,109
Kategats	169,33	31,20	0,184	97,1	2,318	291,2	3,899	0,108
Ivan Bachalov	187,86	45,10	0,240	94,0	2,081	318,0	2,885	0,121
average			0,241		2,085		3,508	0,119

Tab.4. Parameters of operational load distributions of ship general purposes electric generators of bucket dredgers in free-floating state

Dredger	Parameters of load distribution of electric generator			Minimum load		Maximum load		$\frac{N_{EG}^{av}}{\sum N_{AC}^{nom}}$
	N_{EG}^{av}	σ_{EG}	ν_{EG}	N_{EG}^{\min}	$(\beta_{EG})_1$	N_{EG}^{\max}	$(\beta_{EG})_2$	
	kW	kW	-	kW	-	kW	-	
Ivan Bachalov	136,58	26,11	0,191	81,4	2,113	211,7	2,877	0,088
Kategats	130,76	25,32	0,194	74,2	2,233	204,6	2,916	0,084
average			0,192		2,173		2,896	0,086

Tab.5. Parameters of operational load distributions of ship general purposes electric generators of bucket dredgers in the service state of breaks in dredging, of staying and towing

Dredger	Parameters of load distribution of electric generator			Minimum load		Maximum load		$\frac{N_{EG}^{av}}{\sum N_{AC}^{nom}}$
	N_{EG}^{av}	σ_{EG}	ν_{EG}	N_{EG}^{\min}	$(\beta_{EG})_1$	N_{EG}^{\max}	$(\beta_{EG})_2$	
	kW	kW	-	kW	-	kW	-	
Małż II	11,50	1,81	0,157	8,1	1,880	15,2	2,046	0,084
Inż. T. Wenda	18,12	3,53	0,195	10,7	2,103	24,2	1,722	0,057
Rozgwiadza	16,31	2,39	0,146	10,5	2,431	21,3	2,097	0,052
Usedom	82,33	16,96	0,206	56,1	1,547	121,9	2,334	0,054
Kategats	101,87	17,16	0,168	71,2	1,787	141,2	2,292	0,065
average			0,175		1,949		2,098	0,062

$\sum N_{AC}^{nom}$ - total rated power of electric motors of all auxiliary consumers installed onboard

A characteristic feature of bucket dredgers is the great value of the coefficient $(\beta_{EG})_2$ for the state of dredging. It results from a large number of auxiliary technological consumers for which short-lasting cyclic work is characteristic. An example is the dredger *Małż II*, majority of such consumers of which is driven by the main engine which operates within diesel engine – hydraulic systems (Fig. 3), hence the coefficient $(\beta_{EG})_2 = 1,772$ shows the lower value.

The $N_{EG}^{av} / \sum N_{AC}^{nom}$ index values are contained within the range of 0,108 – 0,142 - for the state of dredging, 0,084 – 0,088 - for the state of free-floating, and 0,052 – 0,084 - for the state of breaks in dredging, of staying and towing.

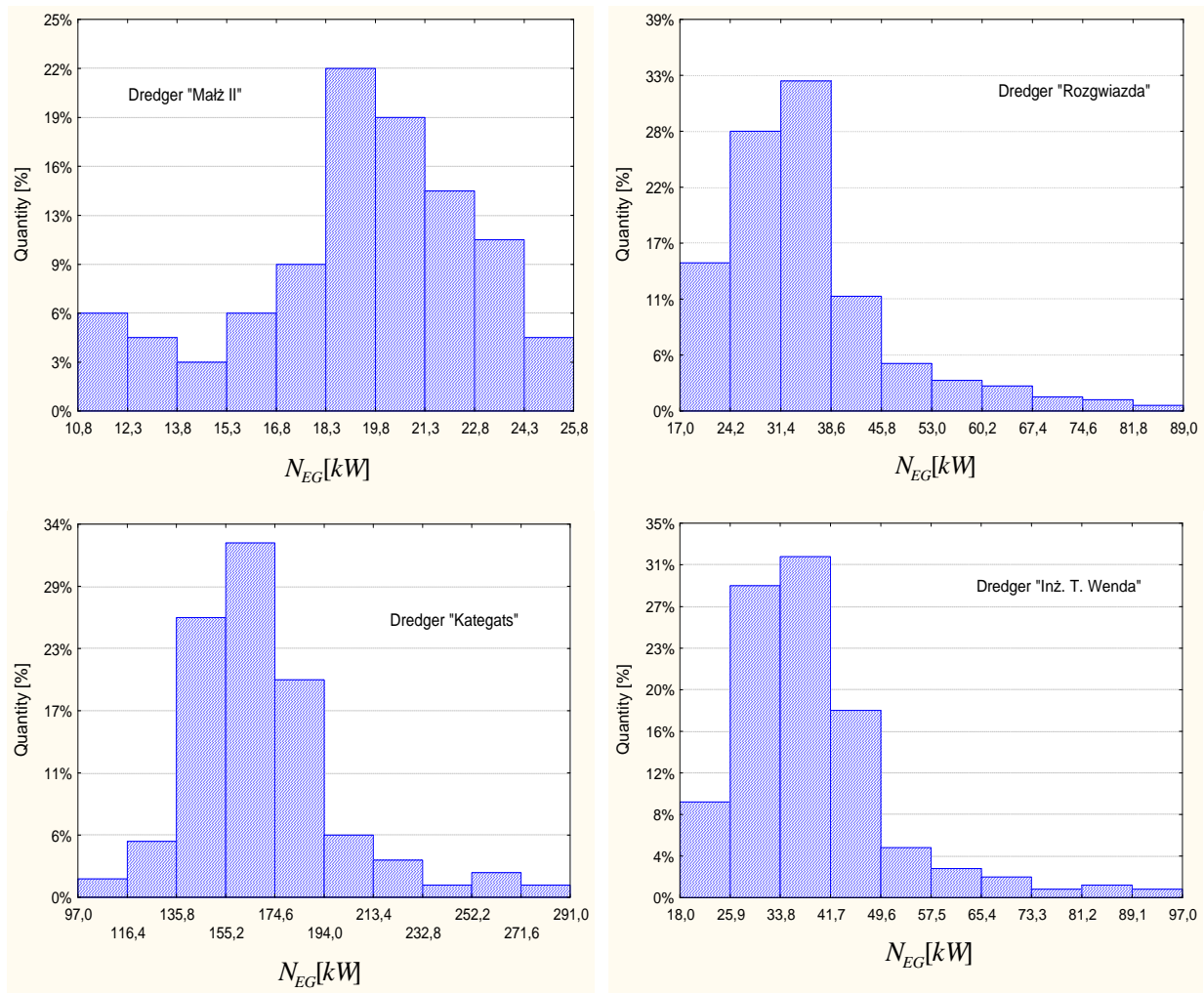

Fig.8. Example load distributions of ship general purposes electric generators of bucket dredgers during dredging work

As the case of main engines, the load distributions of ship general purposes electric generators should be, in compliance with the Lapunov theorem [6], close to normal distribution. The relation (1) was used to determine the minimum sample size for the assumed normal or nearly normal load distribution. The obtained minimum sample size (for the average value $\bar{\sigma}_{EG} = 0,09$) amounts to $m=311$. In all the cases the sample size greatly exceeded the determined minimum sample size. The total distribution of loads of all electric generators, normalized in the interval (0, 1), was subjected to investigations – Fig. 9. The conformity shown in Fig. 9b and 9d, confirms that it is possible to assume the load distributions of ship general purposes electric generators of bucket dredgers during dredging and free-floating, to be normal ones.

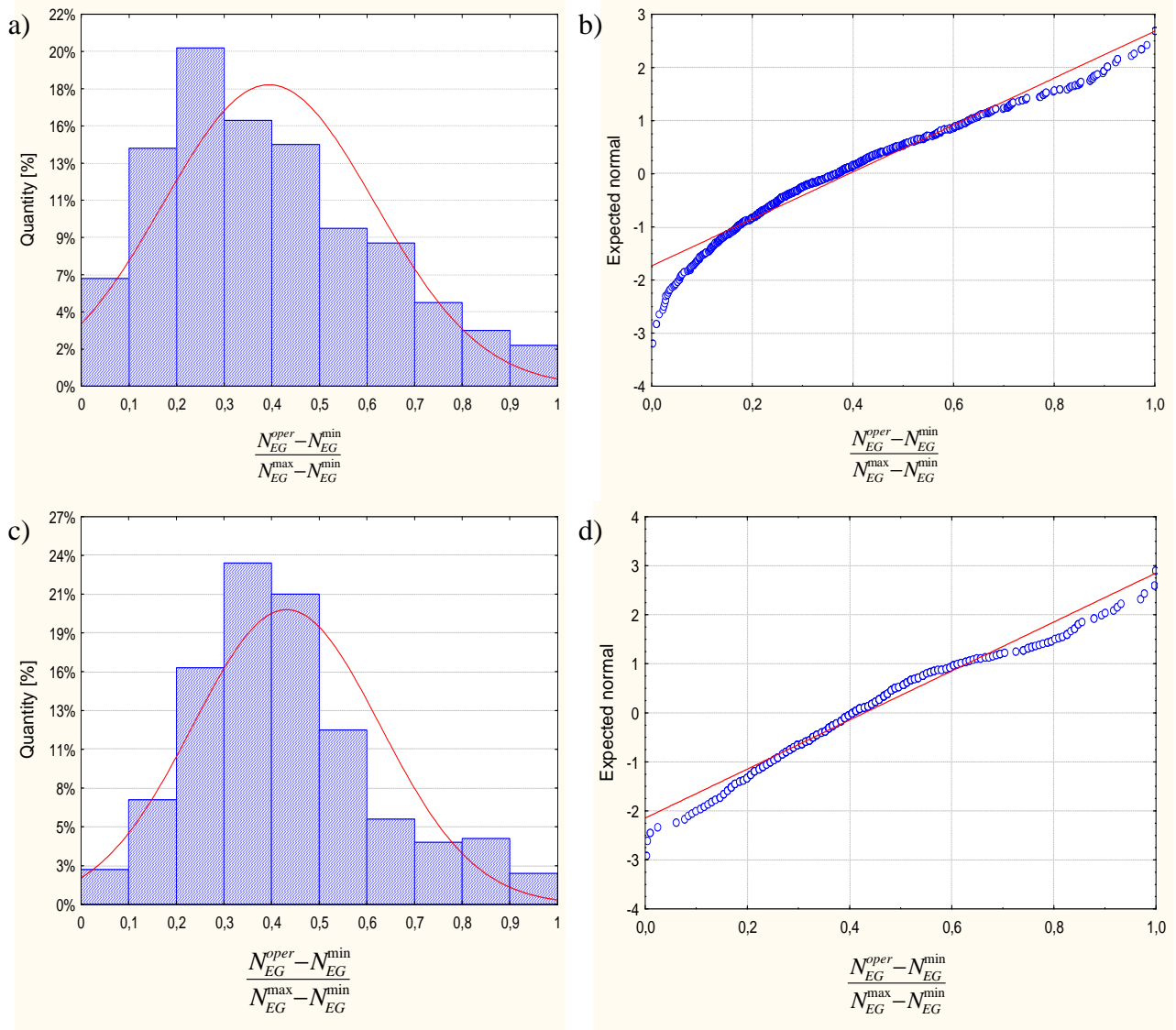

Fig. 9. Characteristics of distributions of total relative loads of ship general purposes electric generators of bucket dredgers during dredging (a,b) and free-floating (c,d)

5. Summary

The performed investigations justify offering the following remarks and conclusions:

1. The values of \bar{N}_{ME}^{av} and ν_{ME} , obtained from measurements, can be used for determining recommended operational loads for main engines to be selected.
For the state of dredging in medium and light soils $\bar{N}_{ME}^{av} = 0,46 - 0,48$ was determined under assumption that the maximum loads of main engines are contained within the range of $(0,85 - 0,9)N_{ME}^{nom}$. For the state of free-floating $\bar{N}_{ME}^{av} = 0,46 - 0,54$ was determined;
2. The indices $N_{EG}^{av} / \sum N_{AC}^{nom}$ as well as the coefficients ν_{EG}^{av} may be used for the predicting of load distributions of ship general purposes electric generators;
3. The load distributions of main engines and ship general purposes electric generators of bucket dredgers in two basic service states: dredging and free-floating, may be deemed normal ones.
4. The state of dredging should be taken as that for which the power system of non-self-propelled bucket dredgers should be designed; in the case of self-propelled dredgers also the state of free-floating should be taken into account.

5. The achieved results may be useful for solving design problems of power plants of bucket dredgers as well as for standardizing fuel consumption.

References

- [1] Bocheński, D., Balcerski, A., Kubiak, A., *Identification of parameters of the systems and data collecting method techniques on dredgers and silting vessels* (in Polish), Research reports no. 28/2000/PB, Faculty of Ocean Engineering and Ship Technology, Gdansk University of Technology, Gdansk 2000.
- [2] Bocheński, D., Kubiak, A., Jurczyk, L., *Measurements of the parameters characterizing operation of technological systems of dredgers* (in Polish), Proc. of the 22nd Symposium on Ship Power Plants *SymSO2001*, Szczecin 2001.
- [3] Bocheński, D. (Supervisor) *et al.*, *Identification investigations of energy consumption and parameters of wining and transporting the winning on selected dredgers and silting vessels* (in Polish), Final report of KBN research project no. 9T12C01718, Research reports no. 8/2002/PB, Faculty of Ocean Engineering and Ship Technology, Gdansk University of Technology, Gdansk 2002.
- [4] Bocheński, D., *Operational load analysis of main power consumers on bucket dredgers* (in Polish), Scientific Bulletins of Polish Naval Academy, no. 162. 24th Symposium on Ship Power Plants *SymSO2005*, Gdynia 2005.
- [5] Bocheński, D., *Analysis of design solutions and relations which determine parameters of power systems on bucket dredgers*, Selected problems of designing and operating of ship power plants (in Polish), 27th Symposium on Ship Power Plants *SymSO2006*, Szczecin 2006.
- [6] Bobrowski, D., *Probability theory for technical applications* (in Polish), Scientific Technical Publishing House (WNT), Warszawa 1986.
- [7] N.N., *Kompleksyjne technologiczne badania i instrukcja po efektywnej eksploatacji ziemsnarjada „Ivan Bachalov”* (in Russian) GDK 627.76.001.5. Rostow upon Don 1985.